

DRAWN: S.HOWARD		DATE		ARCH ENVIRONMENTAL EQUIP., INC.  <b>GORDON DISKIT          BELT ALIGNER          DK-4-12</b>	
CHECKED: G.K.W.		DATE			
APPROVED: N.F.A.		DATE			
SCALE	JOB No.	DRAWING NO. 3893 - C	SHEET	OF	REV.

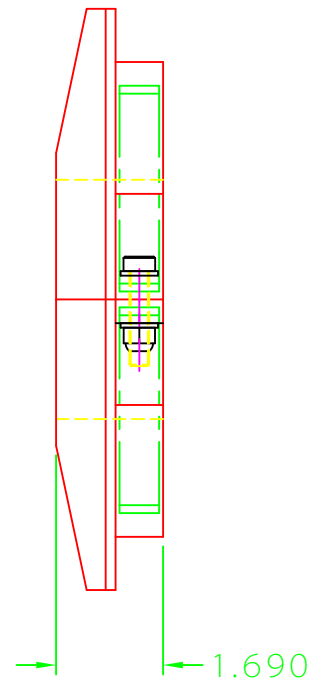
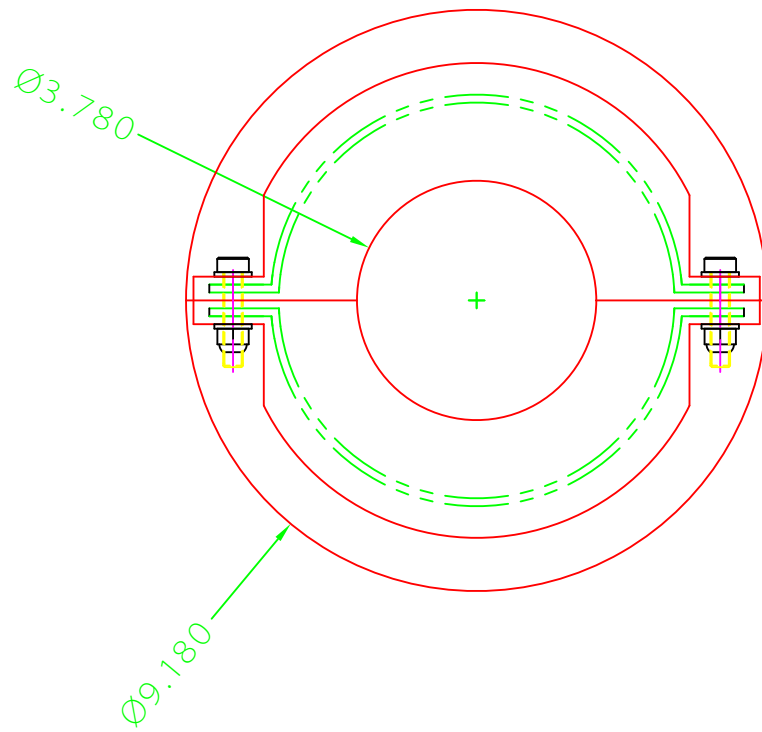

FILENAME= DK-4-9  
 PLOTSCALE=1

DRAWN: S.HOWARD		DATE		ARCH ENVIRONMENTAL EQUIP., INC.	
CHECKED: G.K.W.		DATE			
APPROVED: N.F.A.		DATE			
SCALE	JOB No.	DRAWING NO. 3993 - A	SHEET	OF	REV.

GORDON DISKIT  
 BELT ALIGNER  
 DK - 4 - 9

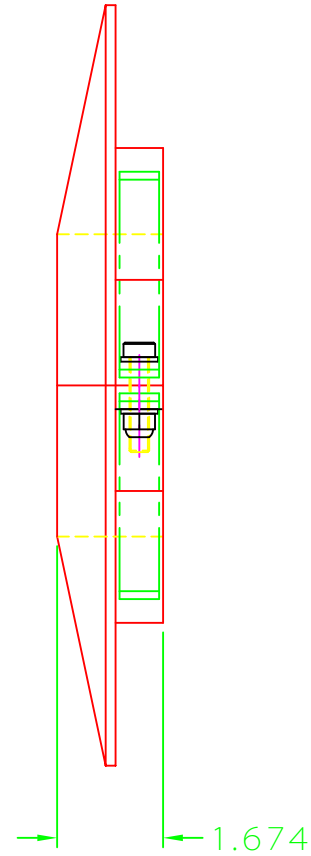
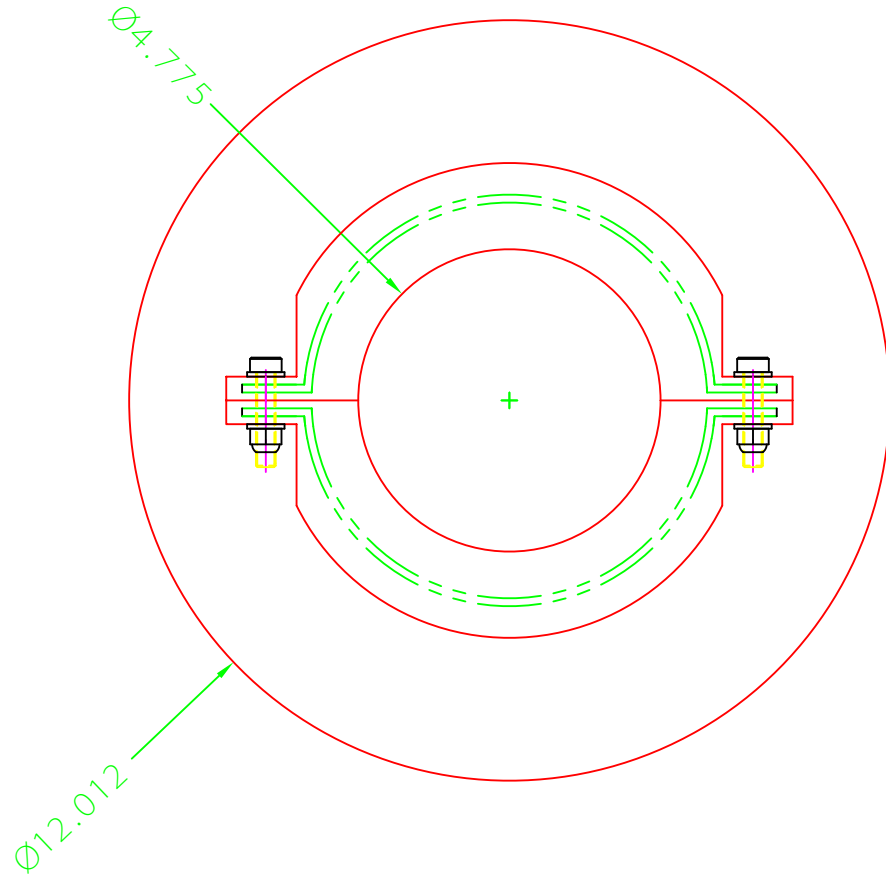

DRAWN:	S.HOWARD	DATE	
CHECKED:	G.K.W.	DATE	
APPROVED:	N.F.A.	DATE	
SCALE	JOB No.		

ARCH ENVIRONMENTAL EQUIP., INC.			
GORDON DISKIT BELT ALIGNER DK-5-12			
DRAWING NO.	3893-D	SHEET	OF
REV.			

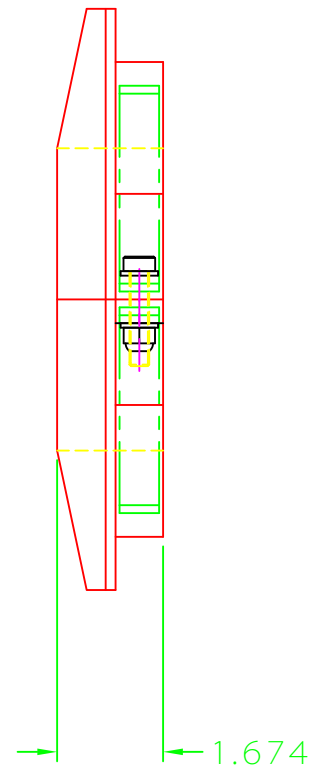
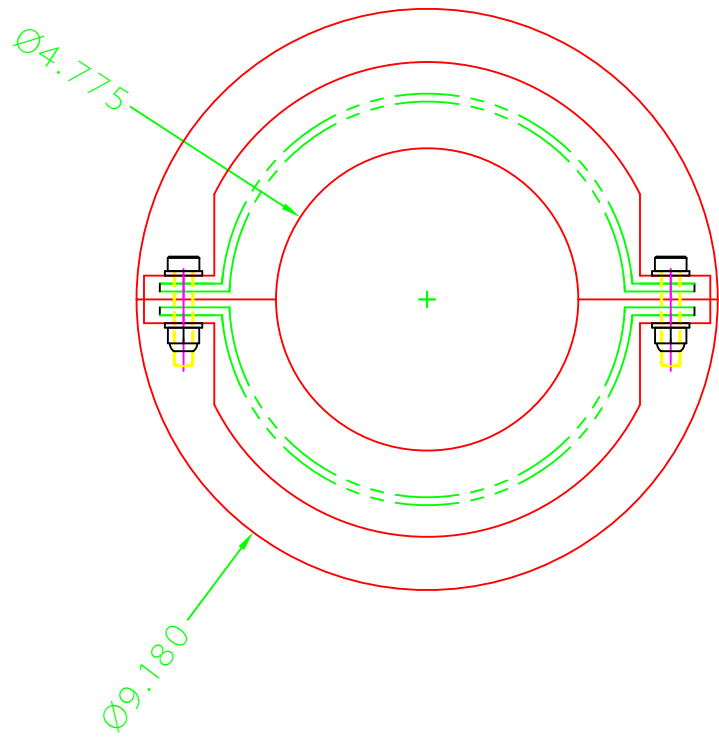

DRAWN: S.HOWARD		DATE		ARCH ENVIRONMENTAL EQUIP., INC.	
CHECKED: G.K.W.		DATE			
APPROVED: N.F.A.		DATE			
SCALE	JOB No.	DRAWING NO. 3893 - E	SHEET	OF	REV.

GORDON DISKIT  
BELT ALIGNER  
DK-5-9

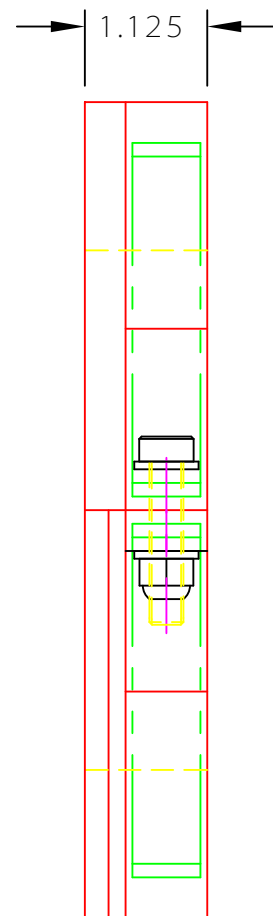
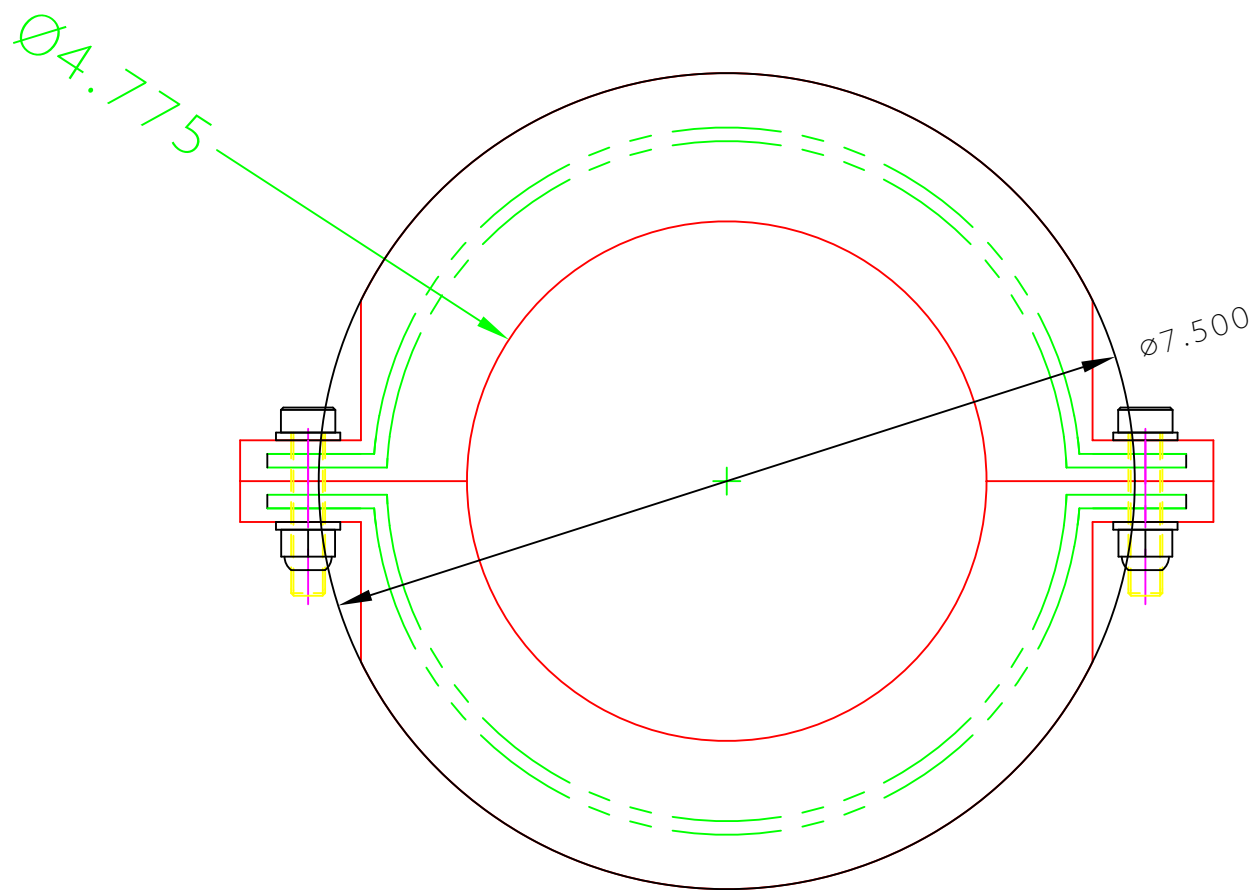

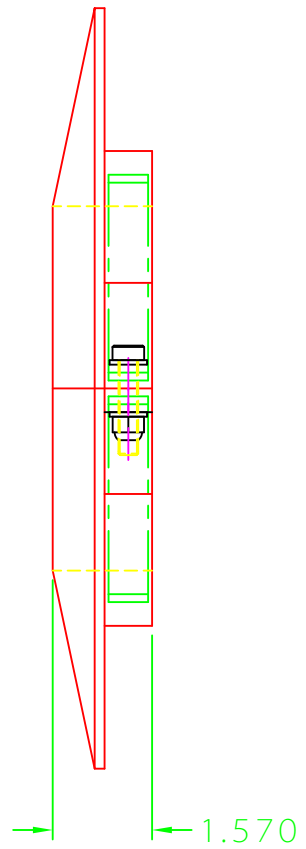
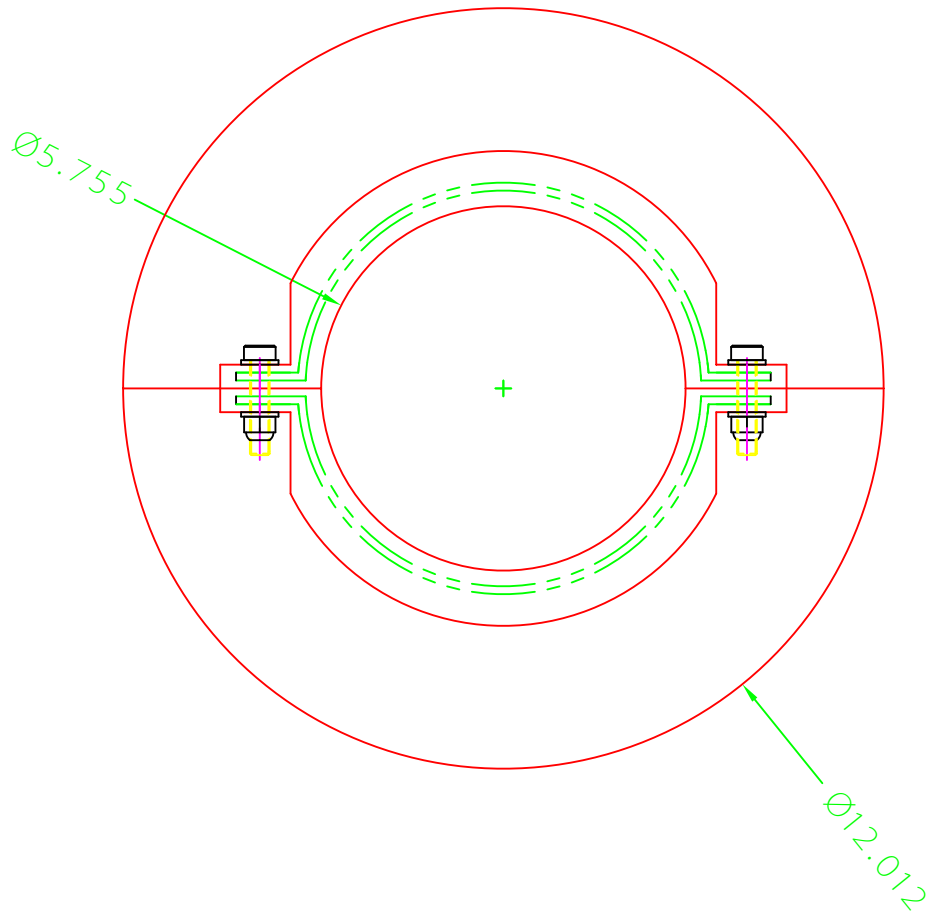

DRAWN: S.HOWARD		DATE		ARCH ENVIRONMENTAL EQUIP., INC.					
CHECKED: G.K.W.		DATE					GORDON DISKIT BELT ALIGNER DK-6-12		
APPROVED: N.F.A.		DATE							
SCALE	JOB NO.	DRAWING NO.	3893-G	SHEET	OF	REV.			

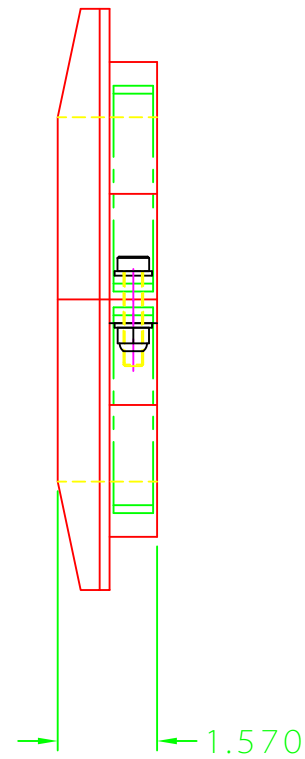
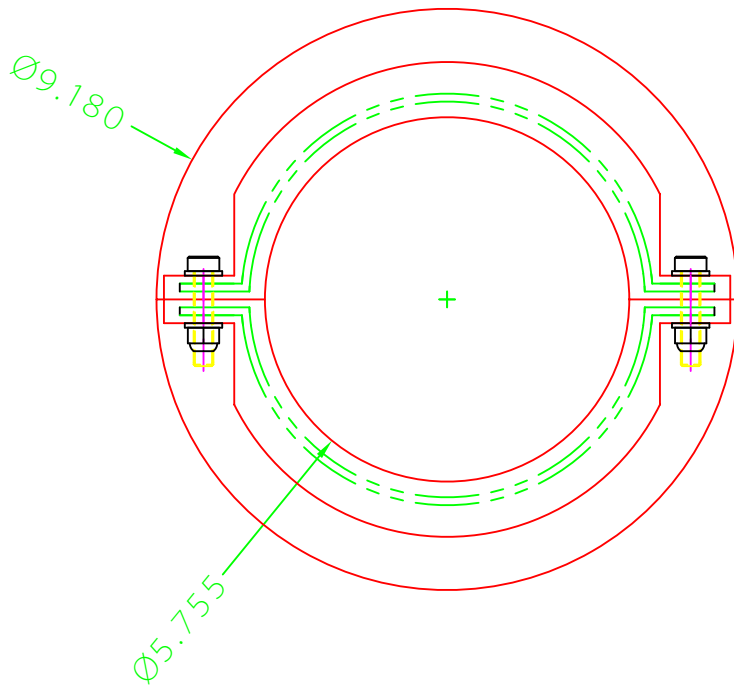

DRAWN:	S.HOWARD	DATE
CHECKED:	G.K.W.	DATE
APPROVED:	N.F.A.	DATE
SCALE	JOB No.	

ARCH ENVIRONMENTAL EQUIP., INC.		
GORDON DISKIT BELT ALIGNER DK-6-9		
DRAWING NO.	SHEET	OF
3893-F		
REV.		